

DALLMER

Drainage systems.
Since 1913

06/2024



Shower channel
CeraLine

01	Introduction	Page 05
02	Shower channel CeraLine	Page 09
03	Order overview	Page 17
04	Product range	Page 21
05	Service	Page 40

01

Introduction

Page 05



"We are an innovative company – but we're also one big family."

Harry Bauermeister,
Managing Director

The Dallmer family business is now in its fourth generation. And even if over the decades times have changed drastically, and along with it the production processes, one thing has remained the same: All Dallmer products are developed, designed and manufactured using state-of-the-art technology in Germany – more specifically, in Arnsberg. The "Made in Germany" seal of quality applies without reservations.

Investing in the future. Dallmer does not only invest money in state-of-the-art machine technology, but also in training and further education for its employees. This ensures that there is specialist know-how at the location.

Bringing together strengths. In order to produce drainage solutions which set standards, you need a genuine innovative spirit and a high degree of experience – and state-of-the-art technology.

Every detail counts. Quality is our top priority. If we all work towards this same goal, we are capable of meeting even the highest demands.



Headquarters in
Arnsberg

Production and
storage rooms



1913

02

Shower channel CeraLine

Page 09

CeraLine has many great features – and now we've added more

Once again, our multi-award-winning
shower channel sets new standards

Immerse yourself in a different world and recharge your batteries. Refresh and stimulate mind, body and soul. More than ever before, bathrooms and spas have come to represent a haven of peace, relaxation and contemplation. Dallmer is committed to fitting these new bathroom landscapes with drainage systems that set new standards in terms of form and functionality.

Dallmer has a long tradition of innovation, as showcased by our shower channels, with which we have created a whole new category of drain fittings – such as CeraLine, a multi-award-winning design product that is well on the way to becoming a modern classic.

Read on for a detailed overview of CeraLine. This brochure is intended as a source of information and inspiration, offering you a stunning array of quality materials and features that enable you to achieve your very own unique and beautifully designed bathroom or spa.

Discover the shower channel CeraLine:
dallmer.com/ceraline



You might also be interested in: Every development starts with an idea: The DallFlex system from Dallmer separated the shower channel from the drain for the first time, to provide flexible installation options for level-access showers. Since then, it has also been possible to build different shower channels on one and the same drain body.

Discover the DallFlex system:
dallmer.com/dallflex



DALLMER

DALLMER

DALLMER

CeraLine – versatile front-of-wall
or in-floor installation

CeraLine F





CeraLine W
(front-of-wall installation)



CeraLine F
(in-floor installation)



or

CeraLine W Duo

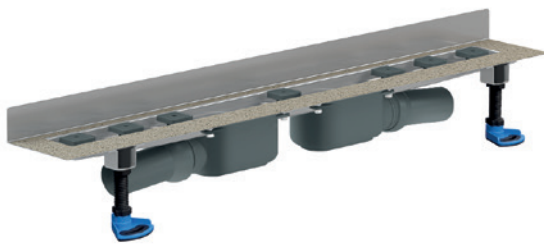

CeraLine F Duo



The CeraLine shower channel is also available with the drain bodies Plan, Nano and vertical. Further information can be found from page 18.

Cover plates Materials and finishes



Standard stainless steel

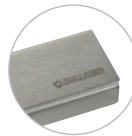

Design stainless steel, brushed



Design stainless steel, polished

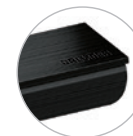

Stainless steel colored, PVD coated black matt

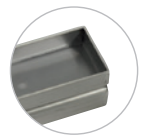

Stainless steel Individual, with recess for customer's floor finish

Build-in height 52 mm (vertical), 68 mm (Nano), 90 mm (Plan) und 110 mm (Standard)

Lengths 500 – 2000 mm

Suitable for flooring 2 – 16 mm with cover plate Standard, 5 – 19 mm with cover plate Design, 16 – 30 mm with cover plate Individual



- ① Cover fitted with levelling screws
- ② Quick and simple to clean thanks to the removable trap insert (conforming to DIN EN 1253)
- ③ With angled flange for wall installation
- ④ Integral sand coated flange for secure bonding of under-tile waterproofing (conforming to DIN 18534)
- ⑤ Acoustically decoupled, height-adjustable mounting feet

Advantages

Creating space for innovative architecture: the multi-award-winning CeraLine shower channel is available in a range of exclusive versions, finishes and material combinations. Thanks to flexible installation options, you can design your bathroom according to personal choice – as a front-of-wall or 'island' shower channel.

- Can be freely positioned front-of-wall or in the showering area
- Fits seamlessly with all tile sizes
- The slim cover plates offer a beautifully elegant solution
- Ideal for rooms with low build-in-height availability (CeraLine Nano, 68 mm)
- Ideal for renovation / refurbishment projects



Installation video:
dallmer.com/installation



03

Order overview

Page 17

CeraLine – Open to any design

CeraLine F



LENGTH		500 mm	600 mm	700 mm	800 mm
CERALINE F (PART NO.)	BUILD-IN HEIGHT 110 mm	520012	520029	520036	520043
CERALINE PLAN F (PART NO.)	BUILD-IN HEIGHT 90 mm	523013	523020	523037	523044
CERALINE NANO F (PART NO.)	BUILD-IN HEIGHT 68 mm	523402	523495	523501	523594

CeraLine W



LENGTH		500 mm	600 mm	700 mm	800 mm
CERALINE W (PART NO.)	BUILD-IN HEIGHT 110 mm	520111	520128	520135	520142
CERALINE PLAN W (PART NO.)	BUILD-IN HEIGHT 90 mm	523112	523129	523136	523143
CERALINE NANO W (PART NO.)	BUILD-IN HEIGHT 68 mm	523006	523099	523105	523198

CeraLine vertical F *



LENGTH		500 mm	600 mm	700 mm	800 mm
CERALINE VERTICAL F (PART NO.)	BUILD-IN HEIGHT 52 mm	521606	521613	521620	521637

CeraLine F Duo



LENGTH		800 mm	900 mm	1000 mm
CERALINE F DUO (PART NO.)	BUILD-IN HEIGHT 110 mm	521804	521811	521828
CERALINE PLAN F DUO (PART NO.)	BUILD-IN HEIGHT 90 mm	521903	521910	521927
CERALINE NANO F DUO (PART NO.)	BUILD-IN HEIGHT 68 mm	522191	522214	522221

CeraLine W Duo

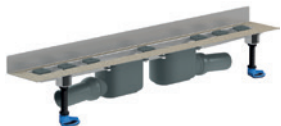

LENGTH		800 mm	900 mm	1000 mm
CERALINE W DUO (PART NO.)	BUILD-IN HEIGHT 110 mm	521859	521866	521873
CERALINE PLAN W DUO (PART NO.)	BUILD-IN HEIGHT 90 mm	521958	521965	521972
CERALINE NANO W DUO (PART NO.)	BUILD-IN HEIGHT 68 mm	522290	522313	522320

CeraLine vertical F Duo*



LENGTH				
CERALINE VERTICAL F DUO (PART NO.)	BUILD-IN HEIGHT 52 mm			

Cover plates



LENGTH	500 mm	600 mm	700 mm	800 mm	900 mm
STAINLESS STEEL STANDARD (PART NO.)	520517	520524	520531	520548	520555
STAINLESS STEEL BRUSHED (PART NO.)	520616	520623	520630	520647	520654
STAINLESS STEEL POLISHED (PART NO.)	523716	523723	523730	523747	523754
STAINLESS STEEL BLACK MATT (PART NO.)	527097	527158	527165	527172	527189
STAINLESS STEEL INDIVIDUAL (PART NO.)	520715	520722	520739	520746	520753

* fire and sound-insulating collar applicable

Material cover plates for shower channel CeraLine

900 mm	1000 mm	1100 mm	1200 mm
520050	520067	520081	520074
523051	523068	523075	523082
523600	523693	523709	523792



Stainless steel Standard

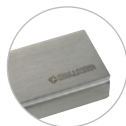

Stainless steel brushed



Stainless steel polished



Stainless steel colored,
PVD coated black matt

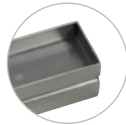

Stainless steel Individual,
with recess for customer's
floor finish

900 mm	1000 mm	1100 mm	1200 mm
520159	520166	520180	520173
523150	523167	523174	523181
523204	523297	523303	523396

900 mm	1000 mm	1100 mm	1200 mm
521644	521651	521668	521675

1100 mm	1200 mm	1300 mm	1400 mm	1500 mm	1600 mm	1700 mm	1800 mm	1900 mm	2000 mm
521835	521842	524010	524027	524034	524041	524058	524065	524072	524089
521934	521941	524508	524515	524522	524539	524546	524553	524560	524577
522238	522276	524713	524720	524737	524744	524751	524768	524775	524782

1100 mm	1200 mm	1300 mm	1400 mm	1500 mm	1600 mm	1700 mm	1800 mm	1900 mm	2000 mm
521880	521897	524096	524102	524119	524126	524133	524140	524157	524164
521989	521996	524584	524591	524607	524614	524621	524638	524645	524652
522337	522375	524799	524805	524812	524829	524836	524843	524850	524867

	1300 mm	1400 mm	1500 mm		1800 mm	1900 mm	2000 mm
	521682	521699	521705		521736	521743	521750

1000 mm	1100 mm	1200 mm	1300 mm	1400 mm	1500 mm	1600 mm	1700 mm	1800 mm	1900 mm	2000 mm
520562	520586	520579	524201	524218	524225	524232	524249	524256	524263	524270
520661	520685	520678	524287	524294	524300	524317	524324	524331	524348	524355
523761	523778	523785								
527196	527240	527257								
520760	520784	520777	524362	524379	524386	524393	524409	524416	524423	524430

04

Product range

Page 21

Shower channel CeraLine



DALLMER shower channel CeraLine F

conforming to DIN EN 1253

Linear drainage, with one drain body, outlet DN 50 horizontal, ball-joint adjustable 0 – 15 degrees

SPECIFICATION

- sound absorbing height adjustable levelling legs
- integral sand coated flange for secure bonding of under-tile waterproofing
- removable trap insert, 50 mm water seal (conforming to DIN EN 1253)
- height adjustable screws
- temporary blanking plate
- tiling gauges
- edge trim jigs

MATERIAL

channel 304 stainless steel, trap polypropylene

FLOW RATE TESTED TO DIN EN 1253
(with 10/20 mm water over grate)

	Required	Dallmer
DN 50	0.8 l/s	0.78/0.84 l/s

ITEM	L 1	L 2	PART NO.
shower channel CeraLine F, 500 mm		600 mm	520012
shower channel CeraLine F, 600 mm		700 mm	520029
shower channel CeraLine F, 700 mm		800 mm	520036
shower channel CeraLine F, 800 mm		900 mm	520043
shower channel CeraLine F, 900 mm		1000 mm	520050
shower channel CeraLine F, 1000 mm		1100 mm	520067
shower channel CeraLine F, 1100 mm		1200 mm	520081
shower channel CeraLine F, 1200 mm		1300 mm	520074

Options for CeraLine F:

Any made-to-measure length up to 1200 mm can be supplied. Please enquire!

CeraLine 600 mm – 1100 mm can be used with the Poresta® BFR 75 unit!

Build-in height 110 mm



shower channel CeraLine F 500 – 1200

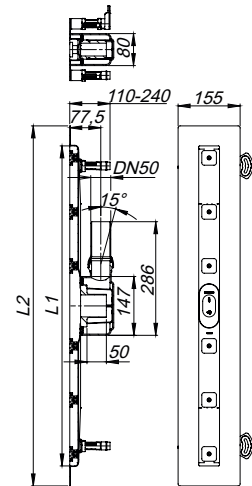

Shower channel CeraLine



DALLMER shower channel CeraLine F Duo

conforming to DIN EN 1253

Linear drainage, with two drain bodies, outlet DN 50 horizontal, ball-joint adjustable 0 – 15 degrees

SPECIFICATION

- sound-insulated, height adjustable levelling legs
- integral sand coated flange for secure bonding of under-tile waterproofing
- removable trap insert, 50 mm water seal (conforming to DIN EN 1253)
- height adjustable pedestals for levelling the cover-plate
- temporary blanking plate
- tiling gauges
- tile-trim jig

MATERIAL

channel 304 stainless steel, trap polypropylene

FLOW RATE TESTED TO DIN EN 1253
(with 20 mm water over grate)

	Required	Dallmer
DN 50	0.8 l/s	1.4 l/s

ITEM	L 1	L 2	L 3	PART NO.
shower channel CeraLine F Duo, 800 mm		900 mm	200 mm	521804
shower channel CeraLine F Duo, 900 mm		1000 mm	300 mm	521811
shower channel CeraLine F Duo, 1000 mm		1100 mm	300 mm	521828
shower channel CeraLine F Duo, 1100 mm		1200 mm	400 mm	521835
shower channel CeraLine F Duo, 1200 mm		1300 mm	400 mm	521842
shower channel CeraLine F Duo, 1300 mm		1400 mm	500 mm	524010
shower channel CeraLine F Duo, 1400 mm		1500 mm	500 mm	524027
shower channel CeraLine F Duo, 1500 mm		1600 mm	600 mm	524034
shower channel CeraLine F Duo, 1600 mm		1700 mm	600 mm	524041
shower channel CeraLine F Duo, 1700 mm		1800 mm	700 mm	524058
shower channel CeraLine F Duo, 1800 mm		1900 mm	700 mm	524065
shower channel CeraLine F Duo, 1900 mm		2000 mm	800 mm	524072
shower channel CeraLine F Duo, 2000 mm		2100 mm	800 mm	524089

Options for CeraLine F Duo:

Any made-to-measure length up to 2000 mm can be supplied. Please enquire!

Build-in height 110 mm

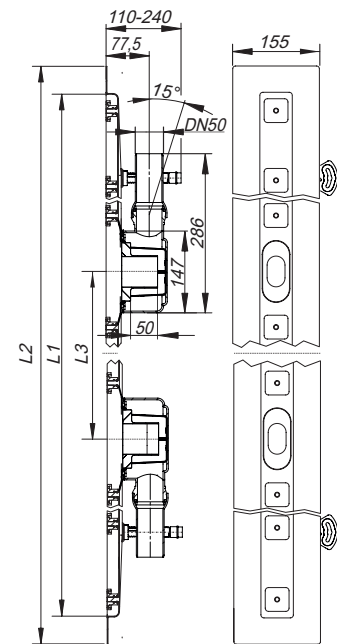

shower channel CeraLine F Duo 800 – 1200

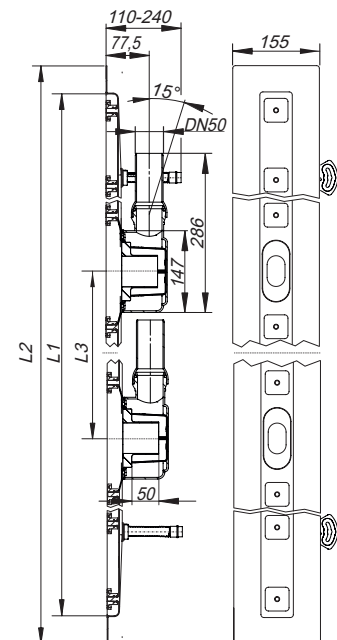

shower channel CeraLine F Duo 1300 – 2000

Shower channel CeraLine



DALLMER shower channel CeraLine W

conforming to DIN EN 1253

Linear drainage for installation at wall, with one drain body, outlet DN 50 horizontal, ball-joint adjustable 0 – 15 degrees

SPECIFICATION

- sound absorbing height adjustable levelling legs
- integral sand coated flange for secure bonding of under-tile waterproofing
- removable trap insert, 50 mm water seal (conforming to DIN EN 1253)
- height adjustable screws
- temporary blanking plate
- tiling gauges
- edge trim jigs

MATERIAL

channel 304 stainless steel, trap polypropylene

FLOW RATE TESTED TO DIN EN 1253 (with 20 mm water over grate)

	Required	Dallmer
DN 50	0.8 l/s	0.8 l/s

ITEM	L 1	L 2	PART NO.
shower channel CeraLine W, 500 mm		600 mm	520111
shower channel CeraLine W, 600 mm		700 mm	520128
shower channel CeraLine W, 700 mm		800 mm	520135
shower channel CeraLine W, 800 mm		900 mm	520142
shower channel CeraLine W, 900 mm		1000 mm	520159
shower channel CeraLine W, 1000 mm		1100 mm	520166
shower channel CeraLine W, 1100 mm		1200 mm	520180
shower channel CeraLine W, 1200 mm		1300 mm	520173

Options for CeraLine W:

- Any made-to-measure length up to 1200 mm can be supplied
- Upstands can be on back, back and one end or back and both ends
- Upstand can be set back for stone, marble wall finish

Please enquire!

CeraLine 600 mm – 1100 mm can be used with the Poresta® BFR 75 unit!

Build-in height 110 mm



shower channel CeraLine W 500 – 1200

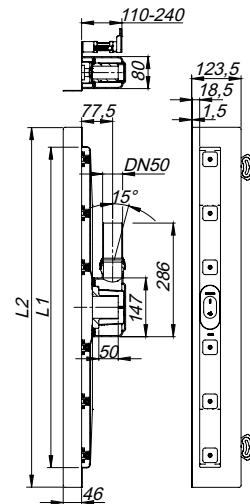

Shower channel CeraLine



DALLMER shower channel CeraLine W Duo

conforming to DIN EN 1253

Linear drainage for installation at wall, with two drain bodies, outlet DN 50 horizontal, ball-joint adjustable 0 – 15 degrees

SPECIFICATION

- sound absorbing height adjustable levelling legs
- integral sand coated flange for secure bonding of under-tile waterproofing
- removable trap insert, 50 mm water seal (conforming to DIN EN 1253)
- height adjustable pedestals for levelling the cover-plate
- temporary blanking plate
- tiling gauges
- edge trim jigs

MATERIAL

channel 304 stainless steel, trap polypropylene

FLOW RATE TESTED TO DIN EN 1253 (with 20 mm water over grate)

	Required	Dallmer
DN 50	0.8 l/s	1.4 l/s

ITEM	L 1	L 2	L 3	PART NO.
shower channel CeraLine W Duo, 800 mm		900 mm	200 mm	521859
shower channel CeraLine W Duo, 900 mm		1000 mm	300 mm	521866
shower channel CeraLine W Duo, 1000 mm		1100 mm	300 mm	521873
shower channel CeraLine W Duo, 1100 mm		1200 mm	400 mm	521880
shower channel CeraLine W Duo, 1200 mm		1300 mm	400 mm	521897
shower channel CeraLine W Duo, 1300 mm		1400 mm	500 mm	524096
shower channel CeraLine W Duo, 1400 mm		1500 mm	500 mm	524102
shower channel CeraLine W Duo, 1500 mm		1600 mm	600 mm	524119
shower channel CeraLine W Duo, 1600 mm		1700 mm	600 mm	524126
shower channel CeraLine W Duo, 1700 mm		1800 mm	700 mm	524133
shower channel CeraLine W Duo, 1800 mm		1900 mm	700 mm	524140
shower channel CeraLine W Duo, 1900 mm		2000 mm	800 mm	524157
shower channel CeraLine W Duo, 2000 mm		2100 mm	800 mm	524164

Options for CeraLine W Duo:

- Any made-to-measure length up to 2000 mm can be supplied
- Upstands can be on back, back and one end or back and both ends
- Upstand can be set back for stone, marble wall finish

Please enquire!

Build-in height 110 mm

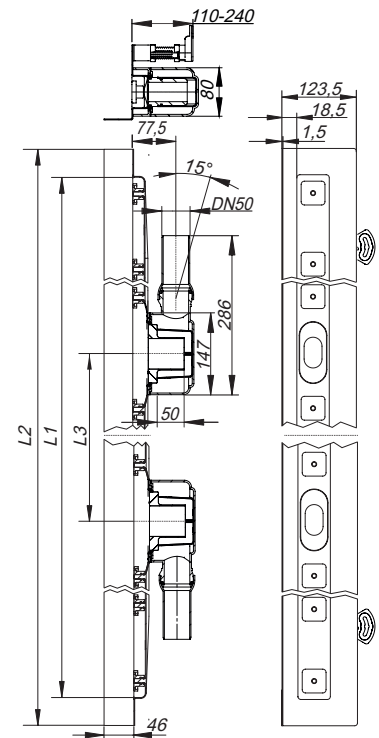
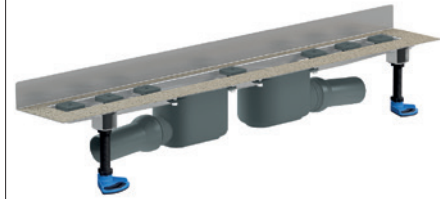

shower channel CeraLine W Duo 800 – 1200

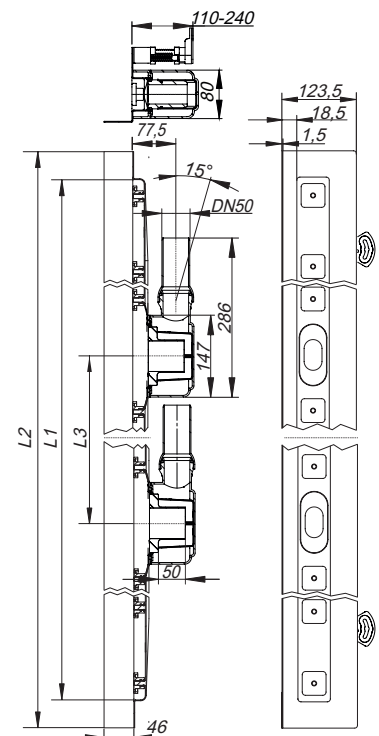

shower channel CeraLine W Duo 1300 – 2000

Shower channel CeraLine



DALLMER shower channel CeraLine Plan F

Linear drainage
with one drain body, outlet DN 50 horizontal, ball-joint adjustable 0 – 15 degrees

SPECIFICATION

- sound absorbing height adjustable levelling legs
- integral sand coated flange for secure bonding of under-tile waterproofing
- removable trap insert, 30 mm water seal (deviating to DIN EN 1253)
- height adjustable screws
- temporary blanking plate
- tiling gauges
- edge trim jigs

MATERIAL

channel 304 stainless steel, trap polypropylene

FLOW RATE FOLLOWING DIN EN 1253 TAB. 3,
(with 20 mm water over grate)

	Required	Dallmer
DN 50	0.4 l/s	0.7 l/s

ITEM	L 1	L 2	PART NO.
shower channel CeraLine Plan F, 500 mm		600 mm	523013
shower channel CeraLine Plan F, 600 mm		700 mm	523020
shower channel CeraLine Plan F, 700 mm		800 mm	523037
shower channel CeraLine Plan F, 800 mm		900 mm	523044
shower channel CeraLine Plan F, 900 mm		1000 mm	523051
shower channel CeraLine Plan F, 1000 mm		1100 mm	523068
shower channel CeraLine Plan F, 1100 mm		1200 mm	523075
shower channel CeraLine Plan F, 1200 mm		1300 mm	523082

Options for CeraLine Plan F:

Any made-to-measure length up to 1200 mm can be supplied. Please enquire!

CeraLine 600 mm – 1100 mm can be used with the Poresta® BFR 75 unit!

Build-in height 90 mm



shower channel CeraLine Plan F 500 – 1200

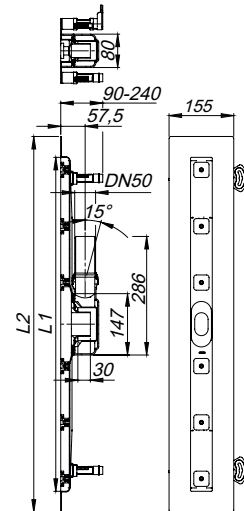

Shower channel CeraLine



DALLMER shower channel CeraLine Plan F Duo

Linear drainage
with two drain bodies, outlet DN 50 horizontal, ball-joint adjustable 0 – 15 degrees

SPECIFICATION

- sound-insulated height adjustable levelling legs
- integral sand coated flange for secure bonding of under-tile waterproofing
- removable trap insert, 30 mm water seal (deviating to DIN EN 1253)
- height adjustable pedestals for levelling the cover-plate
- temporary blanking plate
- tiling gauges
- tile-trim jig

MATERIAL

channel 304 stainless steel, trap polypropylene

FLOW RATE FOLLOWING DIN EN 1253 TAB. 3,
(with 20 mm water over grate)

	Required	Dallmer
DN 50	0.8 l/s	1.2 l/s

ITEM	L 1	L 2	L 3	PART NO.
shower channel CeraLine Plan F Duo, 800 mm		900 mm	200 mm	521903
shower channel CeraLine Plan F Duo, 900 mm		1000 mm	300 mm	521910
shower channel CeraLine Plan F Duo, 1000 mm		1100 mm	300 mm	521927
shower channel CeraLine Plan F Duo, 1100 mm		1200 mm	400 mm	521934
shower channel CeraLine Plan F Duo, 1200 mm		1300 mm	400 mm	521941
shower channel CeraLine Plan F Duo, 1300 mm		1400 mm	500 mm	524508
shower channel CeraLine Plan F Duo, 1400 mm		1500 mm	500 mm	524515
shower channel CeraLine Plan F Duo, 1500 mm		1600 mm	600 mm	524522
shower channel CeraLine Plan F Duo, 1600 mm		1700 mm	600 mm	524539
shower channel CeraLine Plan F Duo, 1700 mm		1800 mm	700 mm	524546
shower channel CeraLine Plan F Duo, 1800 mm		1900 mm	700 mm	524553
shower channel CeraLine Plan F Duo, 1900 mm		2000 mm	800 mm	524560
shower channel CeraLine Plan F Duo, 2000 mm		2100 mm	800 mm	524577

Options for CeraLine Plan F Duo:

Any made-to-measure length up to 2000 mm can be supplied. Please enquire!

Build-in height 90 mm

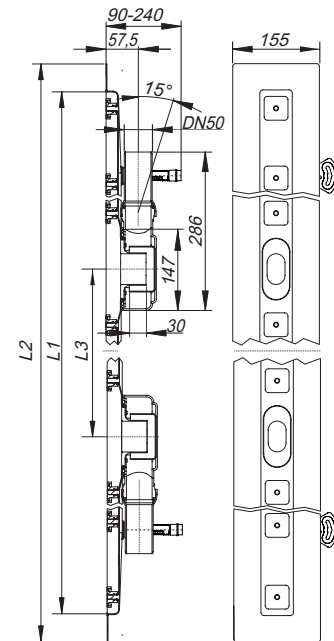

shower channel CeraLine Plan F Duo 800 – 1200

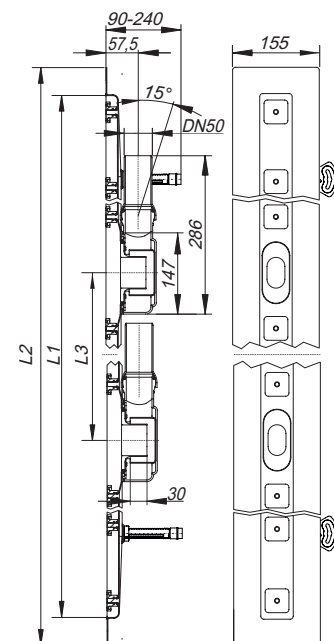

shower channel CeraLine Plan F Duo 1300 – 2000

Shower channel CeraLine



DALLMER shower channel CeraLine Plan W

Linear drainage for installation at wall
with one drain body, outlet DN 50 horizontal, ball-joint adjustable 0 – 15 degrees

SPECIFICATION

- sound absorbing height adjustable levelling legs
- integral sand coated flange for secure bonding of under-tile waterproofing
- removable trap insert, 30 mm water seal (deviating to DIN EN 1253)
- height adjustable screws,
- temporary blanking plate
- tiling gauges
- edge trim jigs

MATERIAL

channel 304 stainless steel, trap polypropylene

FLOW RATE FOLLOWING DIN EN 1253 TAB. 3,
(with 20 mm water over grate)

	Required	Dallmer
DN 50	0.4 l/s	0.7 l/s

ITEM	L 1	L 2	PART NO.
shower channel CeraLine Plan W, 500 mm		600 mm	523112
shower channel CeraLine Plan W, 600 mm		700 mm	523129
shower channel CeraLine Plan W, 700 mm		800 mm	523136
shower channel CeraLine Plan W, 800 mm		900 mm	523143
shower channel CeraLine Plan W, 900 mm		1000 mm	523150
shower channel CeraLine Plan W, 1000 mm		1100 mm	523167
shower channel CeraLine Plan W, 1100 mm		1200 mm	523174
shower channel CeraLine Plan W, 1200 mm		1300 mm	523181

Options for CeraLine Plan W:

- Any made-to-measure length up to 1200 mm can be supplied. Please enquire!
- Upstands can be on back, back and one end or back and both ends
- Upstand can be set back for stone, marble wall finish

Please enquire!

CeraLine 600 mm – 1100 mm can be used with the Poresta® BFR 75 unit!

Build-in height 90 mm



shower channel CeraLine Plan W 500 – 1200

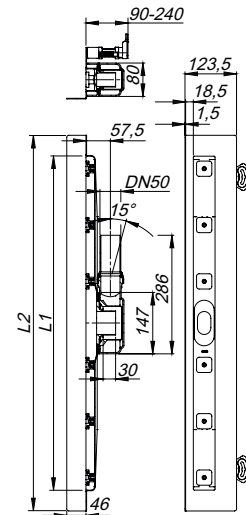

Shower channel CeraLine



DALLMER shower channel CeraLine Plan W Duo

Linear drainage for installation at wall
with two drain bodies, outlet DN 50 horizontal, ball-joint adjustable 0 – 15 degrees

SPECIFICATION

- sound-insulated, height adjustable levelling legs
- integral sand coated flange for secure bonding of under-tile waterproofing
- removable trap insert, 30 mm water seal (deviating to DIN EN 1253)
- height adjustable pedestals for levelling the cover-plate
- temporary blanking plate
- tiling gauges
- tile-trim jig

MATERIAL

channel 304 stainless steel, trap polypropylene

FLOW RATE FOLLOWING DIN EN 1253 TAB. 3,
(with 20 mm water over grate)

	Required	Dallmer
DN 50	0.8 l/s	1.2 l/s

ITEM	L 1	L 2	L 3	PART NO.
shower channel CeraLine Plan W Duo, 800 mm		900 mm	200 mm	521958
shower channel CeraLine Plan W Duo, 900 mm		1000 mm	300 mm	521965
shower channel CeraLine Plan W Duo, 1000 mm		1100 mm	300 mm	521972
shower channel CeraLine Plan W Duo, 1100 mm		1200 mm	400 mm	521989
shower channel CeraLine Plan W Duo, 1200 mm		1300 mm	400 mm	521996
shower channel CeraLine Plan W Duo, 1300 mm		1400 mm	500 mm	524584
shower channel CeraLine Plan W Duo, 1400 mm		1500 mm	500 mm	524591
shower channel CeraLine Plan W Duo, 1500 mm		1600 mm	600 mm	524607
shower channel CeraLine Plan W Duo, 1600 mm		1700 mm	600 mm	524614
shower channel CeraLine Plan W Duo, 1700 mm		1800 mm	700 mm	524621
shower channel CeraLine Plan W Duo, 1800 mm		1900 mm	700 mm	524638
shower channel CeraLine Plan W Duo, 1900 mm		2000 mm	800 mm	524645
shower channel CeraLine Plan W Duo, 2000 mm		2100 mm	800 mm	524652

Options for CeraLine Plan W Duo:

- Any made-to-measure length up to 2000 mm can be supplied
- Upstands can be on back, back and one end or back and both ends
- Upstand can be set back for stone, marble wall finish

Please enquire!

Build-in height 90 mm

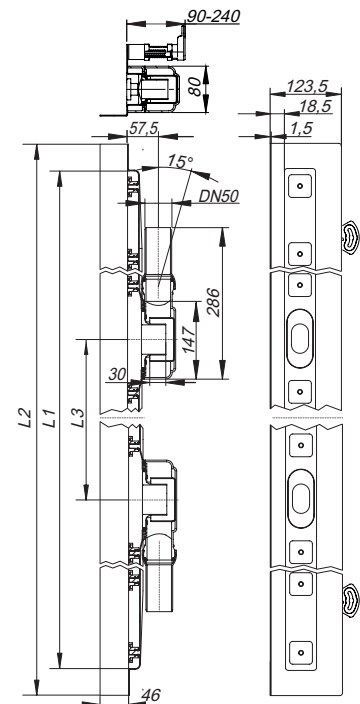
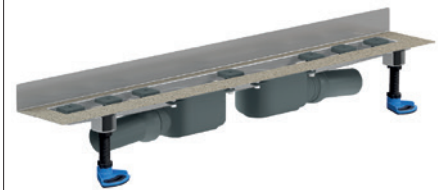

shower channel CeraLine Plan W Duo 800 - 1200

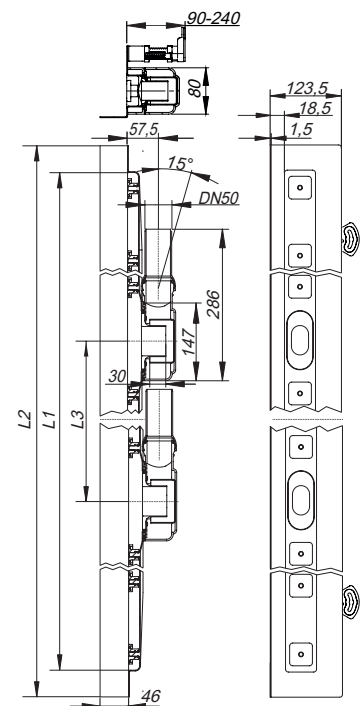

shower channel CeraLine Plan W Duo 1300 – 2000

Shower channel CeraLine



DALLMER shower channel CeraLine Nano F

Linear drainage
with one drain body, outlet DN 50 horizontal

SPECIFICATION

- sound absorbing height adjustable levelling legs
- integral sand coated flange for secure bonding of under-tile waterproofing
- removable trap insert, 24 mm water seal (deviating to DIN EN 1253)
- height adjustable screws
- temporary blanking plate
- tiling gauges
- edge trim jigs

MATERIAL

channel 304 stainless steel, trap polypropylene

FLOW RATE FOLLOWING DIN EN 1253 TAB. 3,
(with 20 mm water over grate)

	Required	Dallmer
DN 50	0.4 l/s	0.46 l/s

ITEM	L 1	L 2	PART NO.
shower channel CeraLine Nano F, 500 mm		600 mm	523402
shower channel CeraLine Nano F, 600 mm		700 mm	523495
shower channel CeraLine Nano F, 700 mm		800 mm	523501
shower channel CeraLine Nano F, 800 mm		900 mm	523594
shower channel CeraLine Nano F, 900 mm		1000 mm	523600
shower channel CeraLine Nano F, 1000 mm		1100 mm	523693
shower channel CeraLine Nano F, 1100 mm		1200 mm	523709
shower channel CeraLine Nano F, 1200 mm		1300 mm	523792

Options for CeraLine Nano F:

Any made-to-measure length up to 1200 mm can be supplied. Please enquire!

CeraLine 600 mm – 1100 mm can be used with the Poresta® BFR 75 unit!

CeraLine 500 mm – 1100 mm can be used with the Schedel-Element LINE Dallmer UNIVERSAL!

Build-in height 68 mm

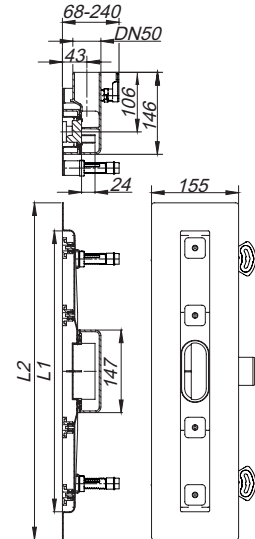

shower channel CeraLine Nano F 500 – 1200

Shower channel CeraLine



DALLMER shower channel CeraLine Nano F Duo

Linear drainage
with two drain bodies, outlet DN 50 horizontal

SPECIFICATION

- sound absorbing height adjustable levelling legs
- integral sand coated flange for secure bonding of under-tile waterproofing
- removable trap insert, 24 mm water seal (deviating to DIN EN 1253)
- height adjustable screws
- temporary blanking plate
- tiling gauges
- edge trim jigs

MATERIAL

channel 304 stainless steel, trap polypropylene

FLOW RATE FOLLOWING DIN EN 1253 TAB. 3,
(with 20 mm water over grate)

	Required	Dallmer
DN 50	0.8 l/s	0.82 l/s

ITEM	L 1	L 2	L 3	PART NO.
shower channel CeraLine Nano F Duo, 800 mm		900 mm	200 mm	522191
shower channel CeraLine Nano F Duo, 900 mm		1000 mm	300 mm	522214
shower channel CeraLine Nano F Duo, 1000 mm		1100 mm	300 mm	522221
shower channel CeraLine Nano F Duo, 1100 mm		1200 mm	400 mm	522238
shower channel CeraLine Nano F Duo, 1200 mm		1300 mm	400 mm	522276
shower channel CeraLine Nano F Duo, 1300 mm		1400 mm	500 mm	524713
shower channel CeraLine Nano F Duo, 1400 mm		1500 mm	500 mm	524720
shower channel CeraLine Nano F Duo, 1500 mm		1600 mm	600 mm	524737
shower channel CeraLine Nano F Duo, 1600 mm		1700 mm	600 mm	524744
shower channel CeraLine Nano F Duo, 1700 mm		1800 mm	700 mm	524751
shower channel CeraLine Nano F Duo, 1800 mm		1900 mm	700 mm	524768
shower channel CeraLine Nano F Duo, 1900 mm		2000 mm	800 mm	524775
shower channel CeraLine Nano F Duo, 2000 mm		2100 mm	800 mm	524782

Options for CeraLine Nano F Duo:

Any made-to-measure length up to 2000 mm can be supplied. Please enquire!

Build-in height 68 mm

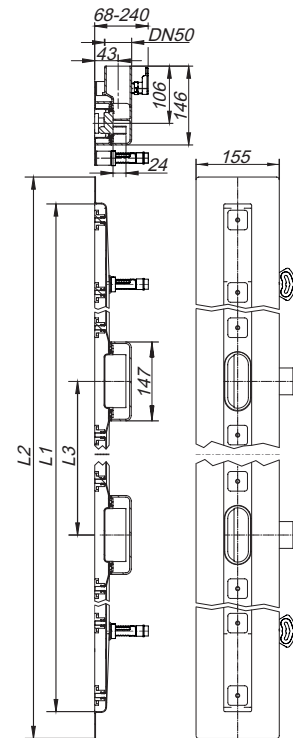

shower channel CeraLine Nano F Duo 800 – 2000

Shower channel CeraLine



DALLMER shower channel CeraLine Nano W

Linear drainage for installation at wall
with one drain body, outlet DN 50 horizontal

SPECIFICATION

- sound absorbing height adjustable levelling legs
- integral sand coated flange for secure bonding of under-tile waterproofing
- removable trap insert, 24 mm water seal (deviating to DIN EN 1253)
- height adjustable screws
- temporary blanking plate
- tiling gauges
- edge trim jigs

MATERIAL

channel 304 stainless steel, trap polypropylene

FLOW RATE FOLLOWING DIN EN 1253 TAB. 3,
(with 20 mm water over grate)

	Required	Dallmer
DN 50	0.4 l/s	0.46 l/s

ITEM	L 1	L 2	PART NO.
shower channel CeraLine Nano W,	500 mm	600 mm	523006
shower channel CeraLine Nano W,	600 mm	700 mm	523099
shower channel CeraLine Nano W,	700 mm	800 mm	523105
shower channel CeraLine Nano W,	800 mm	900 mm	523198
shower channel CeraLine Nano W,	900 mm	1000 mm	523204
shower channel CeraLine Nano W,	1000 mm	1100 mm	523297
shower channel CeraLine Nano W,	1100 mm	1200 mm	523303
shower channel CeraLine Nano W,	1200 mm	1300 mm	523396

Options for CeraLine Nano W:

- Any made-to-measure length up to 1200 mm can be supplied.
- Upstands can be on back, back and one end or back and both ends
- Upstand can be set back for stone, marble wall finish

Please enquire!

CeraLine 600 mm – 1100 mm can be used with the Poresta® BFR 75 unit!

CeraLine 500 mm – 1100 mm can be used with the Schedel-Element LINE Dallmer UNIVERSAL!

Build-in height 68 mm

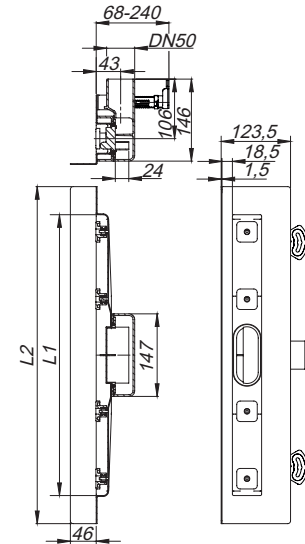

shower channel CeraLine Nano W 500 – 1200

Shower channel CeraLine



DALLMER shower channel CeraLine Nano W Duo

Linear drainage for installation at wall
with two drain bodies, outlet DN 50 horizontal

SPECIFICATION

- sound absorbing height adjustable levelling legs
- integral sand coated flange for secure bonding of under-tile waterproofing
- removable trap insert, 24 mm water seal (deviating to DIN EN 1253)
- height adjustable screws
- temporary blanking plate
- tiling gauges
- edge trim jigs

MATERIAL

channel 304 stainless steel, trap polypropylene

FLOW RATE FOLLOWING DIN EN 1253 TAB. 3,
(with 20 mm water over grate)

	Required	Dallmer
DN 50	0.8 l/s	0.82 l/s

ITEM	L 1	L 2	L 3	PART NO.
shower channel CeraLine Nano W Duo, 800 mm		900 mm	200 mm	522290
shower channel CeraLine Nano W Duo, 900 mm		1000 mm	300 mm	522313
shower channel CeraLine Nano W Duo, 1000 mm		1100 mm	300 mm	522320
shower channel CeraLine Nano W Duo, 1100 mm		1200 mm	400 mm	522337
shower channel CeraLine Nano W Duo, 1200 mm		1300 mm	400 mm	522375
shower channel CeraLine Nano W Duo, 1300 mm		1400 mm	500 mm	524799
shower channel CeraLine Nano W Duo, 1400 mm		1500 mm	500 mm	524805
shower channel CeraLine Nano W Duo, 1500 mm		1600 mm	600 mm	524812
shower channel CeraLine Nano W Duo, 1600 mm		1700 mm	600 mm	524829
shower channel CeraLine Nano W Duo, 1700 mm		1800 mm	700 mm	524836
shower channel CeraLine Nano W Duo, 1800 mm		1900 mm	700 mm	524843
shower channel CeraLine Nano W Duo, 1900 mm		2000 mm	800 mm	524850
shower channel CeraLine Nano W Duo, 2000 mm		2100 mm	800 mm	524867

Options for CeraLine Nano W Duo:

- Any made-to-measure length up to 2000 mm can be supplied
- Upstands can be on back, back and one end or back and both ends
- Upstand can be set back for stone, marble wall finish

Please enquire!

Build-in height 68 mm

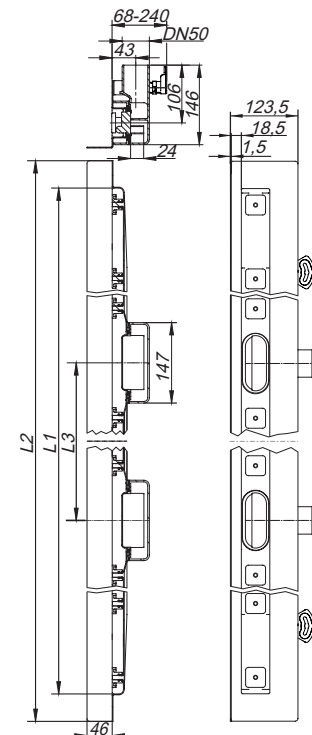

shower channel CeraLine Nano W Duo 800 – 2000

Shower channel CeraLine



DALLMER shower channel CeraLine vertical F

conforming to DIN EN 1253

Linear drainage, with one drain body 40 S, outlet DN 50 vertical

SPECIFICATION

- sound absorbing height adjustable levelling legs
- integral sand coated flange for secure bonding of under-tile waterproofing
- removable trap insert, 50 mm water seal (conforming to DIN EN 1253)
- height adjustable screws
- temporary blanking plate
- tiling gauges
- edge trim jigs

MATERIAL

channel 304 stainless steel, trap polypropylene

FLOW RATE TESTED TO DIN EN 1253
(with 10/20 mm water over grate)

	Required	Dallmer
DN 50	0.8 l/s	1.18/1.22 l/s

ITEM	L 1	L 2	PART NO.
shower channel CeraLine vertical F, 500 mm		600 mm	521606
shower channel CeraLine vertical F, 600 mm		700 mm	521613
shower channel CeraLine vertical F, 700 mm		800 mm	521620
shower channel CeraLine vertical F, 800 mm		900 mm	521637
shower channel CeraLine vertical F, 900 mm		1000 mm	521644
shower channel CeraLine vertical F, 1000 mm		1100 mm	521651
shower channel CeraLine vertical F, 1100 mm		1200 mm	521668
shower channel CeraLine vertical F, 1200 mm		1300 mm	521675

Fire protection system 2 (Part No. 515025) applicable.

Options for CeraLine vertical F:

- Any made-to-measure length up to 1200 mm can be supplied.
- From 900 – 1200 mm, two traps can be also be fitted for 1.4 l/sec flow rate

Please enquire!

Build-in height 52 mm

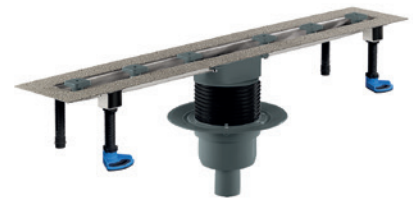

shower channel CeraLine vertical F 500 – 1200

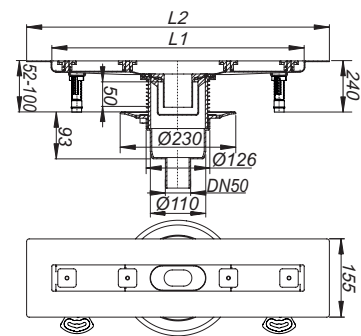

Shower channel CeraLine



DALLMER shower channel CeraLine vertical F Duo

conforming to DIN EN 1253

Linear drainage, with two floor drain bodies CIRCO V with +/- 15 mm lateral adjustment, outlet DN 50/DN 70 vertical

SPECIFICATION

- sound-insulated height adjustable levelling legs
- integral sand coated flange for secure bonding of under-tile waterproofing
- removable trap insert, 50 mm water seal (conforming to DIN EN 1253)
- height adjustable screws for levelling the cover-plate
- temporary blanking plate
- tiling gauges
- edge trim jig

MATERIAL

channel 304 stainless steel, drain body polypropylene;

FLOW RATE TESTED TO DIN EN 1253 (with 10/20 mm water over grate)

	Required	Dallmer
DN 50	0.8 l/s	2.4/2.5 l/s

ITEM	L 1	L 2	L 3	PART NO.
shower channel CeraLine vertical F Duo, 1300 mm	1400 mm	500 mm	521682	
shower channel CeraLine vertical F Duo, 1400 mm	1500 mm	500 mm	521699	
shower channel CeraLine vertical F Duo, 1500 mm	1600 mm	600 mm	521705	
shower channel CeraLine vertical F Duo, 1800 mm	1900 mm	700 mm	521736	
shower channel CeraLine vertical F Duo, 1900 mm	2000 mm	800 mm	521743	
shower channel CeraLine vertical F Duo, 2000 mm	2100 mm	800 mm	521750	

Fire protection system 1 (Part No. 515018) applicable.

Options for CeraLine vertical F Duo:

Any made-to-measure length up to 2000 mm can be supplied. Please enquire!

Build-in height 52 mm



shower channel CeraLine
vertical F Duo 1300 – 2000

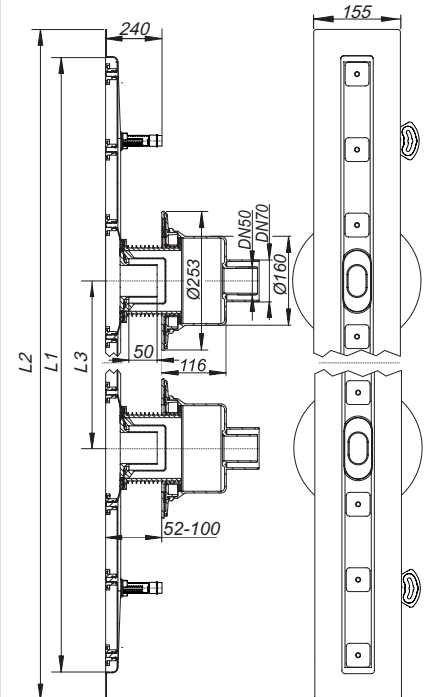

Shower channel CeraLine

DALLMER cover plate CeraLine Standard

Cover plate for all CeraLine channels, suitable for all tile, stone finishes 2 – 16 mm (incl. adhesive), 40 mm wide

MATERIAL

304 stainless steel, load class K 3 (300 kg)

ITEM	LENGTH	PART NO.
cover plate CeraLine Standard	500 mm	520517
cover plate CeraLine Standard	600 mm	520524
cover plate CeraLine Standard	700 mm	520531
cover plate CeraLine Standard	800 mm	520548
cover plate CeraLine Standard	900 mm	520555
cover plate CeraLine Standard	1000 mm	520562
cover plate CeraLine Standard	1100 mm	520586
cover plate CeraLine Standard	1200 mm	520579
cover plate CeraLine Standard	1300 mm	524201
cover plate CeraLine Standard	1400 mm	524218
cover plate CeraLine Standard	1500 mm	524225
cover plate CeraLine Standard	1600 mm	524232
cover plate CeraLine Standard	1700 mm	524249
cover plate CeraLine Standard	1800 mm	524256
cover plate CeraLine Standard	1900 mm	524263
cover plate CeraLine Standard	2000 mm	524270

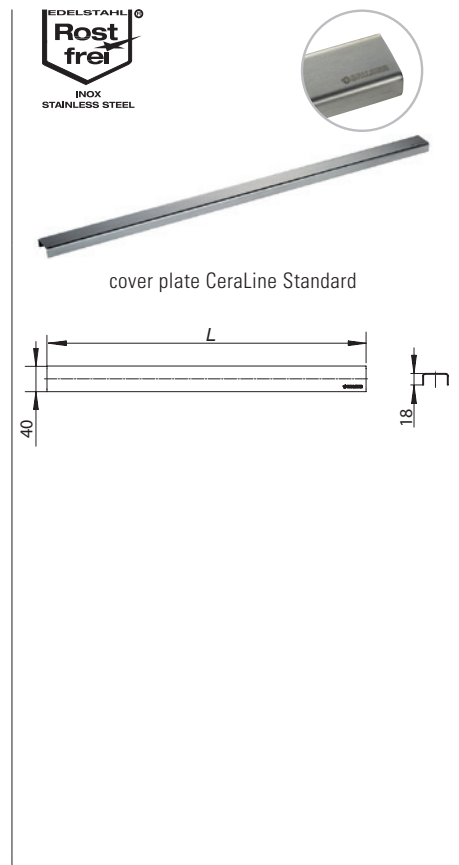

DALLMER cover plate CeraLine Design brushed finish

Cover plate for all CeraLine channels, suitable for all tile, stone finishes 5 – 19 mm (incl. adhesive), 40 mm wide

MATERIAL

304 stainless steel, 3 mm veneer, brushed, load class K 3 (300 kg)

ITEM	LENGTH	PART NO.
cover plate CeraLine Design brushed finish	500 mm	520616
cover plate CeraLine Design brushed finish	600 mm	520623
cover plate CeraLine Design brushed finish	700 mm	520630
cover plate CeraLine Design brushed finish	800 mm	520647
cover plate CeraLine Design brushed finish	900 mm	520654
cover plate CeraLine Design brushed finish	1000 mm	520661
cover plate CeraLine Design brushed finish	1100 mm	520685
cover plate CeraLine Design brushed finish	1200 mm	520678
cover plate CeraLine Design brushed finish	1300 mm	524287
cover plate CeraLine Design brushed finish	1400 mm	524294
cover plate CeraLine Design brushed finish	1500 mm	524300
cover plate CeraLine Design brushed finish	1600 mm	524317
cover plate CeraLine Design brushed finish	1700 mm	524324
cover plate CeraLine Design brushed finish	1800 mm	524331
cover plate CeraLine Design brushed finish	1900 mm	524348
cover plate CeraLine Design brushed finish	2000 mm	524355

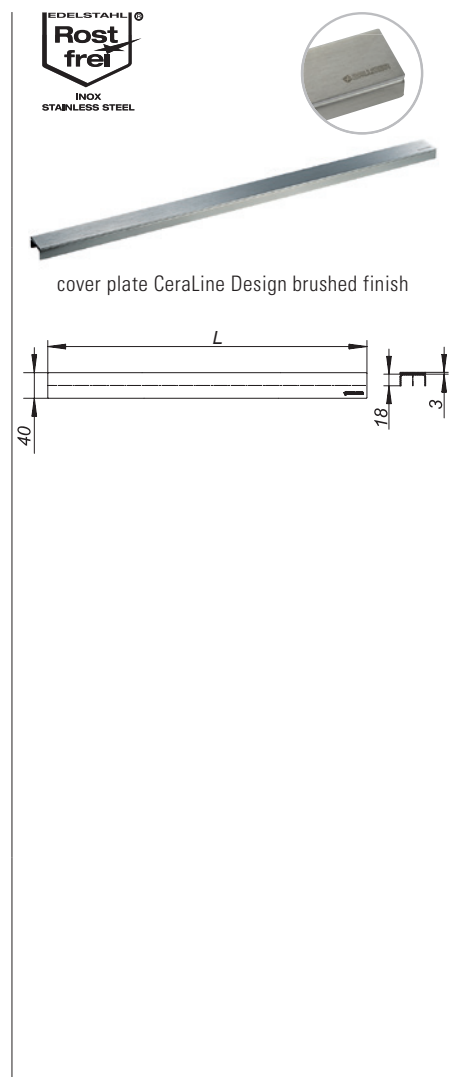

Shower channel CeraLine

DALLMER stainless steel polish

to clean and polish uncoated, matt stainless steel covers

SPECIFICATION

- 100 ml cleaner
- applicator
- buffing pad
- manual

ITEM	PART NO.
stainless steel polish	520494



stainless steel polish

DALLMER cover plate CeraLine Design stainless steel polished

Cover plate for all CeraLine channels, suitable for all tile, stone finishes 5 – 19 mm (incl. adhesive), 40 mm wide

MATERIAL

304 stainless steel, 3 mm veneer, mirror polished, load class K 3 (300 kg)

ITEM	LENGTH	PART NO.
cover plate CeraLine Design stainless steel polished	500 mm	523716
cover plate CeraLine Design stainless steel polished	600 mm	523723
cover plate CeraLine Design stainless steel polished	700 mm	523730
cover plate CeraLine Design stainless steel polished	800 mm	523747
cover plate CeraLine Design stainless steel polished	900 mm	523754
cover plate CeraLine Design stainless steel polished	1000 mm	523761
cover plate CeraLine Design stainless steel polished	1100 mm	523778
cover plate CeraLine Design stainless steel polished	1200 mm	523785



cover plate CeraLine Design stainless steel polished

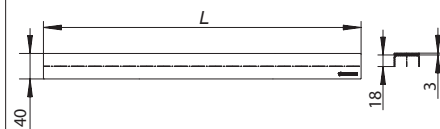

DALLMER cover plate CeraLine black matt

Cover plate for all CeraLine channels, suitable for all tile, stone finishes 5 – 19 mm (incl. adhesive), 40 mm wide

MATERIAL

304 stainless steel, 3 mm veneer, PVD coating in black matt, load class K 3 (300 kg)

ITEM	LENGTH	PART NO.
cover plate CeraLine black matt	500 mm	527097
cover plate CeraLine black matt	600 mm	527158
cover plate CeraLine black matt	700 mm	527165
cover plate CeraLine black matt	800 mm	527172
cover plate CeraLine black matt	900 mm	527189
cover plate CeraLine black matt	1000 mm	527196
cover plate CeraLine black matt	1100 mm	527240
cover plate CeraLine black matt	1200 mm	527257

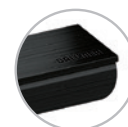

cover plate CeraLine black matt

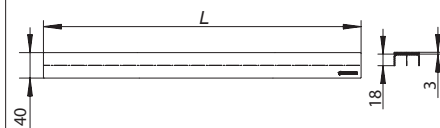

Due to the technological production possibilities, the nature of the raw material and the lighting conditions, there may be slight colour deviations in the PVD surfaces.

Shower channel CeraLine

DALLMER cover plate CeraLine Individual

Cover plate for all CeraLine channels, with recess for customer's individual floor finish, suitable for all tile, stone finishes 16 – 30 mm (incl. adhesive), 40 mm wide

MATERIAL

304 stainless steel, load class K 3 (300 kg)

ITEM	LENGTH	PART NO.
cover plate CeraLine Individual	500 mm	520715
cover plate CeraLine Individual	600 mm	520722
cover plate CeraLine Individual	700 mm	520739
cover plate CeraLine Individual	800 mm	520746
cover plate CeraLine Individual	900 mm	520753
cover plate CeraLine Individual	1000 mm	520760
cover plate CeraLine Individual	1100 mm	520784
cover plate CeraLine Individual	1200 mm	520777
cover plate CeraLine Individual	1300 mm	524362
cover plate CeraLine Individual	1400 mm	524379
cover plate CeraLine Individual	1500 mm	524386
cover plate CeraLine Individual	1600 mm	524393
cover plate CeraLine Individual	1700 mm	524409
cover plate CeraLine Individual	1800 mm	524416
cover plate CeraLine Individual	1900 mm	524423
cover plate CeraLine Individual	2000 mm	524430

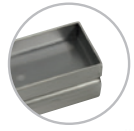

cover plate CeraLine Individual

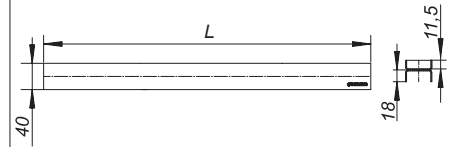

Shower channel CeraLine

DALLMER natural stone kit CeraLine

2 nos. pedestals, extra long for installation/height adjustment of CeraLine cover plate in floors with thicker finishes, e.g. natural stone

CeraLine	kits needed	Combination with cover plate CeraLine	height adjustable
500 – 600	2	Standard	15 – 29 mm
700 – 1000	3	Design	18 – 32 mm
1100 – 1200	4	Glass	21 – 35 mm
1300 – 1700	5	Individuell	29 – 43 mm
1800 – 2000	6		

ITEM	PART NO.
natural stone kit CeraLine built until July 2013	520913
natural stone kit CeraLine	523976

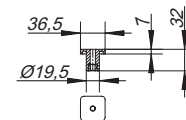

DALLMER adjustable pedestals

Standard height pedestals (supplied x 2), available as spare parts

CeraLine	kits needed
500 – 600	2
700 – 1000	3
1100 – 1200	4
1300 – 1700	5
1800 – 2000	6

ITEM	PART NO.
adjustable pedestals built until July 2013	521019
adjustable pedestals	523983

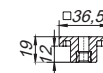

DALLMER service device CeraLine

for easy removing of all CeraLine covers as well as locking and unlocking of the lockable types

MATERIAL

304 stainless steel

ITEM	PART NO.
service device CeraLine	521088

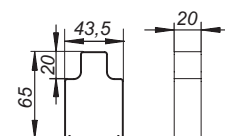

DALLMER sound-insulating pad CeraLine

for use with floor channel CeraLine.

Tested to conform to DIN 4109/VDI 4100, certificate P BA 221/2008 (CeraLine).

ITEM	DIMENSION	PART NO.
sound-insulating pad CeraLine	500 x 250 mm	520869

Channels 1300 - 2000 needs two sound-insulating pads CeraLine.

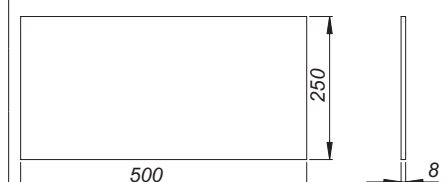

Service

Our products at a glance

Help for planning and installation

Discover our diverse drainage systems and get an overview of our product categories on our website dallmer.com

Planners, architects and installation technicians can visit dallmer.com/service for useful tools and documents which provide them with support during the entire process, from planning to installation.



Installation instructions



DXF drawings



Data sheets



BIM – building information modelling



System sections



Configurator

The Dallmer Sessions online. video. live.



If you are abreast of the state-of-the-art of drainage technologies, changes to standards and directives, and current bathroom trends, you have a clear advantage which you can pass on to your customers. Dallmer's training opportunities now make it even easier to keep up to date.

For more information and current scheduled events, visit dallmer.com/sessions

10-year warranty*

A promise which we are happy for you to pass on to your customers.

Dallmer GmbH + Co. KG
Wiebelsheidestraße 25
59757 Arnsberg
Germany

T +49 2932 9616-0
E info@dallmer.de
W dallmer.com

DW20094 / 06/2024_PDF
WEEE-Reg.-Nr. DE 98946358

